

BHI260AB Shuttle Board

GENERAL DESCRIPTION

Bosch Sensortec’s BHI260AB shuttle board is a PCB with the BHI260AB, a smart sensor hub with integrated IMU sensor, mounted on it.

In addition to the BHI260AB, the board includes

- ▶ on M2 master interface (configured as I2C):
 - ▶ a BME280 environmental sensor (p, rH, T)
 - ▶ a BMM150 magnetometer
 - ▶ an AK09915 magnetometer

on QSPI interface:

- ▶ a W25Q32FWSSI 4M-Byte flash memory connected to the BHI260AB.

Addition sensors can be connected to the M3 I2C bus, using connector J8.

The shuttle board allows easy access to pins of the smart sensor hub via a simple socket. The shuttle board comes pre-mounted on a level-shifter board, which allows the PCB stack to be directly plugged into Bosch Sensortec’s advanced development tool (application board).



BHI260AB shuttle board mounted on level-shifter board (product photo may differ from real product appearance).

Do not connect the shuttle board directly to the application board, as this can lead to severe damage of the shuttle board and its components.

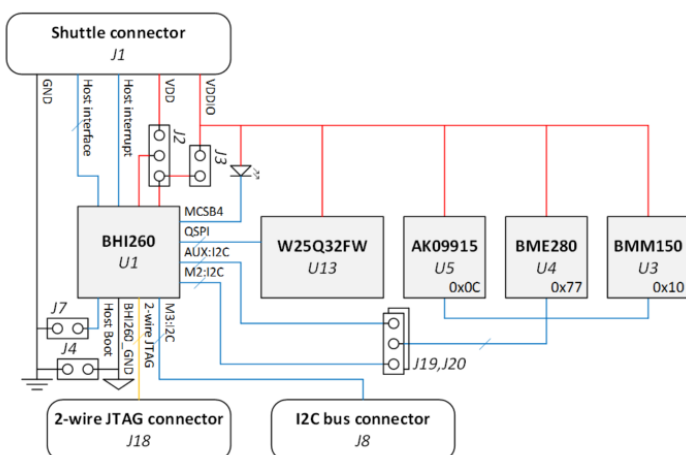

Block diagram of BHI260AB shuttle board

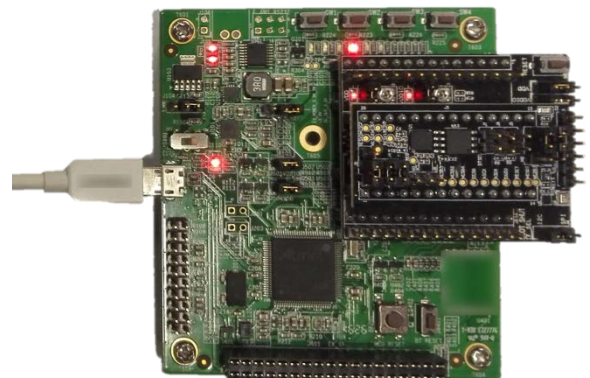

Connection of shuttle board, level shifter board and application board

Designator	Function	Description																																	
J1	Shuttle board connector	<table border="1"> <thead> <tr> <th>Pin number</th> <th>Pin name</th> <th>Description</th> </tr> </thead> <tbody> <tr> <td>1</td> <td>VDD</td> <td>Power supply (1.8V only!)</td> </tr> <tr> <td>2</td> <td>VDDIO</td> <td>Power supply (1.8V only!)</td> </tr> <tr> <td>3,23</td> <td>GND</td> <td>Ground</td> </tr> <tr> <td>4,15</td> <td>MISO</td> <td>Master-input-slave-output data pin of SPI bus (connected to BHI260AB host interface)</td> </tr> <tr> <td>5,17</td> <td>MOSI</td> <td>Master-output-slave-input data pin of SPI bus, or SDA of I2C bus (connected to BHI260AB host interface)</td> </tr> <tr> <td>6,18</td> <td>SCK</td> <td>Clock pin of both SPI and I2C bus (connected to BHI260AB host interface)</td> </tr> <tr> <td>7</td> <td>CS</td> <td>Chip selection pin of SPI bus (connected to BHI260AB host interface)</td> </tr> <tr> <td>21</td> <td>INT</td> <td>Host interrupt pin (connected to BHI260AB host interrupt)</td> </tr> <tr> <td>13,12,11, 10,28,27, 26,25,24</td> <td>COD[x]</td> <td>Device code for Application board, COD of BHI260AB shuttle board is [100011001].</td> </tr> <tr> <td>8,9,14, 15,16,19, 20,22,</td> <td>NC</td> <td>Not used.</td> </tr> </tbody> </table>	Pin number	Pin name	Description	1	VDD	Power supply (1.8V only!)	2	VDDIO	Power supply (1.8V only!)	3,23	GND	Ground	4,15	MISO	Master-input-slave-output data pin of SPI bus (connected to BHI260AB host interface)	5,17	MOSI	Master-output-slave-input data pin of SPI bus, or SDA of I2C bus (connected to BHI260AB host interface)	6,18	SCK	Clock pin of both SPI and I2C bus (connected to BHI260AB host interface)	7	CS	Chip selection pin of SPI bus (connected to BHI260AB host interface)	21	INT	Host interrupt pin (connected to BHI260AB host interrupt)	13,12,11, 10,28,27, 26,25,24	COD[x]	Device code for Application board, COD of BHI260AB shuttle board is [100011001].	8,9,14, 15,16,19, 20,22,	NC	Not used.
		Pin number	Pin name	Description																															
		1	VDD	Power supply (1.8V only!)																															
		2	VDDIO	Power supply (1.8V only!)																															
		3,23	GND	Ground																															
		4,15	MISO	Master-input-slave-output data pin of SPI bus (connected to BHI260AB host interface)																															
		5,17	MOSI	Master-output-slave-input data pin of SPI bus, or SDA of I2C bus (connected to BHI260AB host interface)																															
		6,18	SCK	Clock pin of both SPI and I2C bus (connected to BHI260AB host interface)																															
		7	CS	Chip selection pin of SPI bus (connected to BHI260AB host interface)																															
		21	INT	Host interrupt pin (connected to BHI260AB host interrupt)																															
13,12,11, 10,28,27, 26,25,24	COD[x]	Device code for Application board, COD of BHI260AB shuttle board is [100011001].																																	
8,9,14, 15,16,19, 20,22,	NC	Not used.																																	
J2,J3,J4	Access points to BHI260AB supply (e.g. for power measurement)	J2: BHI260AB VDD pad J3: BHI260AB VDDIO pad J4: BHI260AB_GND (GND+GNDIO) line																																	
J5,J6	Pull-up resistors for host interface running in I2C mode	J5: BHI260AB HSCX pad(SCK) J6: BHI260AB HSDX pad(SDA)																																	
J7	Boot source selection	J7: BHI260AB HOSTBOOT pad																																	
J8	M3 I2C interface for bus extensions	<table border="1"> <thead> <tr> <th>Pin number</th> <th>Pin name</th> <th>Description</th> </tr> </thead> <tbody> <tr> <td>1</td> <td>M3_SDA</td> <td>SDA pin of M3, with a 4.7kohm pull-up to 1.8V VDDIO</td> </tr> <tr> <td>2</td> <td>M3_SCL</td> <td>SCL pin of M3, with a 4.7kohm pull-up to 1.8V VDDIO</td> </tr> <tr> <td>3</td> <td>GND</td> <td>Ground pin.</td> </tr> </tbody> </table>	Pin number	Pin name	Description	1	M3_SDA	SDA pin of M3, with a 4.7kohm pull-up to 1.8V VDDIO	2	M3_SCL	SCL pin of M3, with a 4.7kohm pull-up to 1.8V VDDIO	3	GND	Ground pin.																					
		Pin number	Pin name	Description																															
		1	M3_SDA	SDA pin of M3, with a 4.7kohm pull-up to 1.8V VDDIO																															
		2	M3_SCL	SCL pin of M3, with a 4.7kohm pull-up to 1.8V VDDIO																															
3	GND	Ground pin.																																	
J18	2-wire JTAG connector	<table border="1"> <thead> <tr> <th>Pin number</th> <th>Pin name</th> <th>Description</th> </tr> </thead> <tbody> <tr> <td>1</td> <td>TMS</td> <td>TMS pin of 2-wire JTAG.</td> </tr> <tr> <td>2,3</td> <td>NC</td> <td>Not used.</td> </tr> <tr> <td>4</td> <td>CLK</td> <td>CLK pin of 2-wire JTAG.</td> </tr> <tr> <td>5</td> <td>GND</td> <td>Ground pin.</td> </tr> <tr> <td>6</td> <td>VDDIO</td> <td>Power supply of JTAG, connected to VDDIO of BHI260AB.</td> </tr> </tbody> </table>	Pin number	Pin name	Description	1	TMS	TMS pin of 2-wire JTAG.	2,3	NC	Not used.	4	CLK	CLK pin of 2-wire JTAG.	5	GND	Ground pin.	6	VDDIO	Power supply of JTAG, connected to VDDIO of BHI260AB.															
		Pin number	Pin name	Description																															
		1	TMS	TMS pin of 2-wire JTAG.																															
		2,3	NC	Not used.																															
		4	CLK	CLK pin of 2-wire JTAG.																															
5	GND	Ground pin.																																	
6	VDDIO	Power supply of JTAG, connected to VDDIO of BHI260AB.																																	
J19,J20	Bus master selection for I2C sensors on shuttle board	<table border="1"> <thead> <tr> <th>Jumper setting</th> <th>Bus master of sensors</th> </tr> </thead> <tbody> <tr> <td>M2 (Left)</td> <td>M2 of BHI260AB</td> </tr> <tr> <td>AUX (Right)</td> <td>AUX of BHI260AB</td> </tr> </tbody> </table>	Jumper setting	Bus master of sensors	M2 (Left)	M2 of BHI260AB	AUX (Right)	AUX of BHI260AB																											
		Jumper setting	Bus master of sensors																																
		M2 (Left)	M2 of BHI260AB																																
AUX (Right)	AUX of BHI260AB																																		

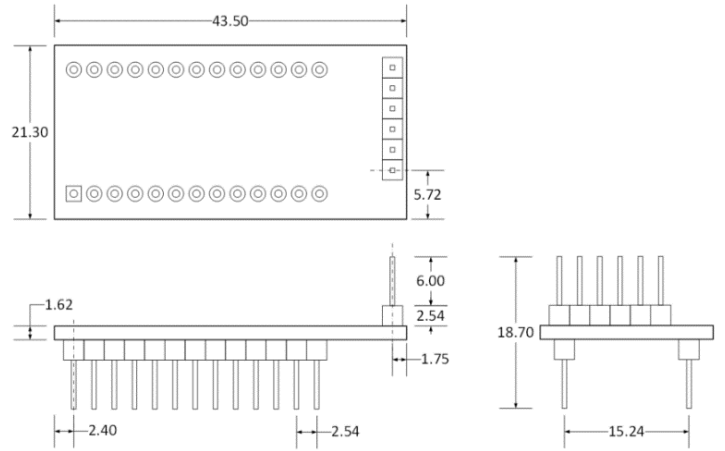
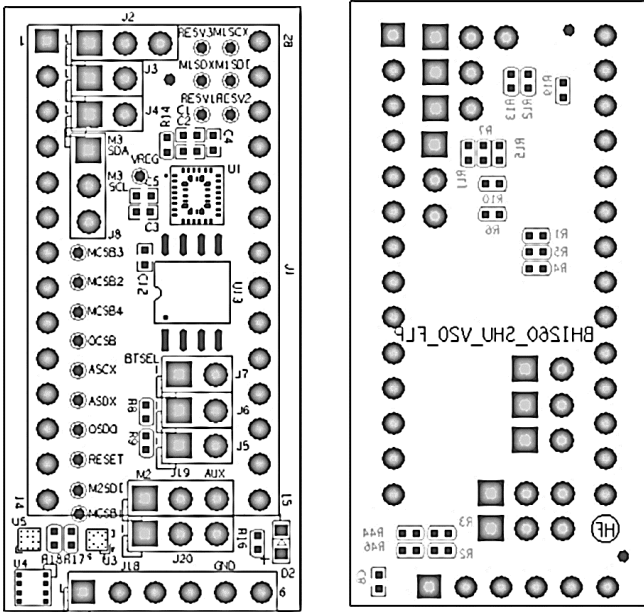

BHI260AB shuttle board outline dimensions (in mm)

BHI260AB shuttle board layout – placement (top, bottom)

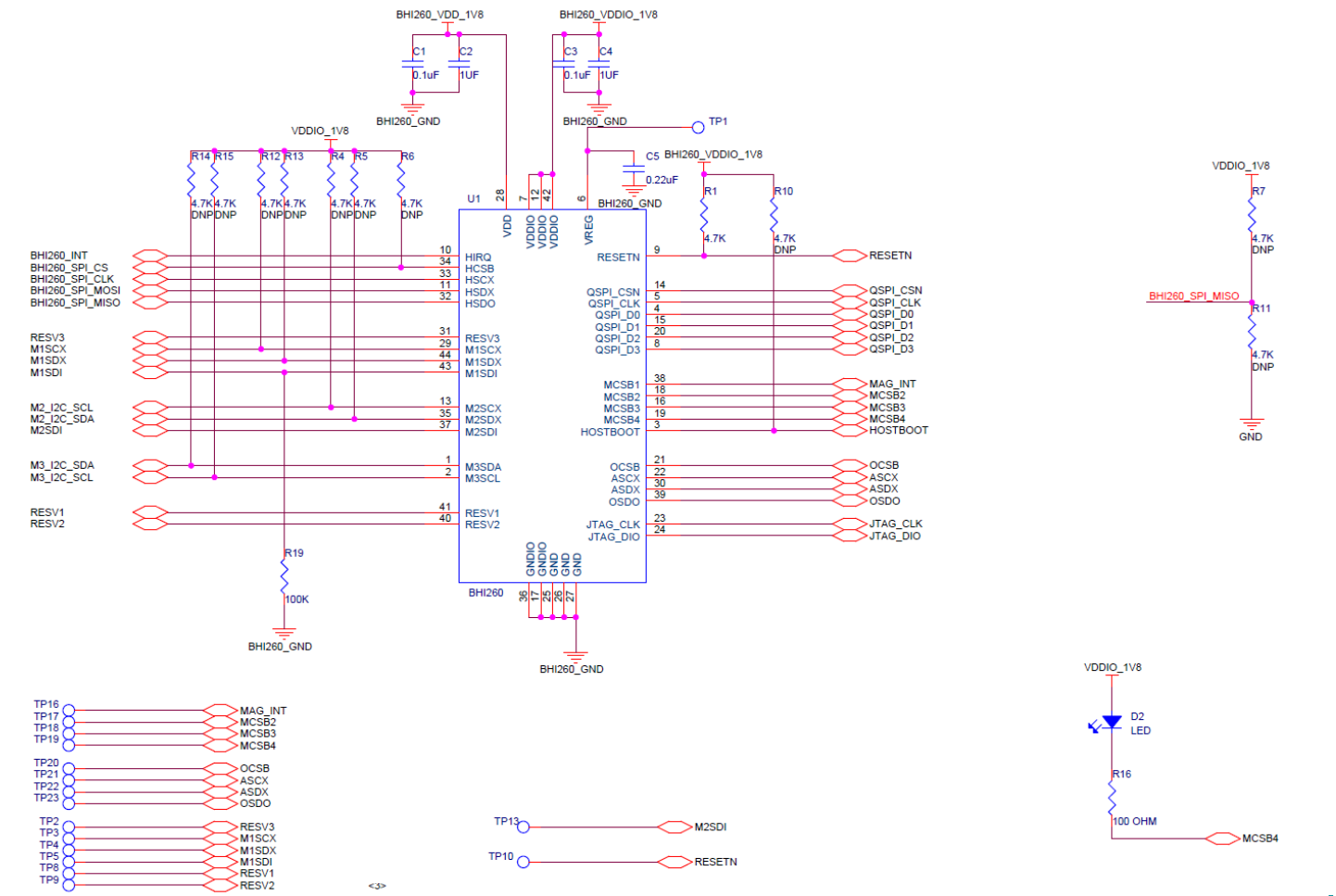

BHI260AB shuttle board schematics

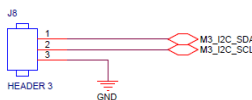
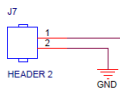
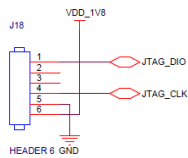
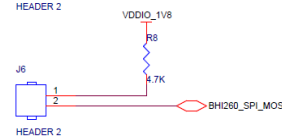
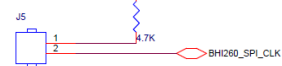
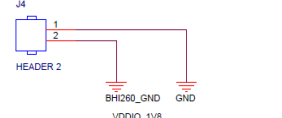
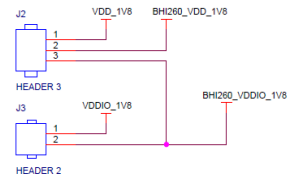
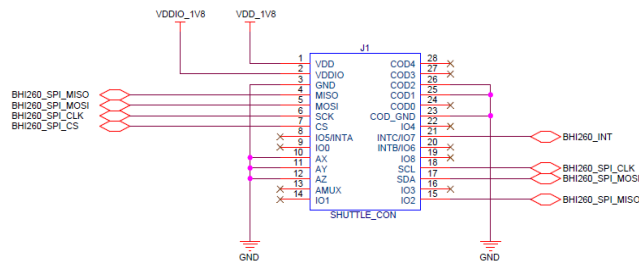
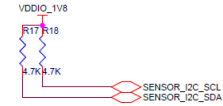
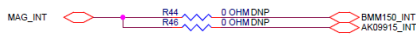
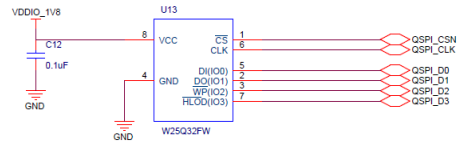
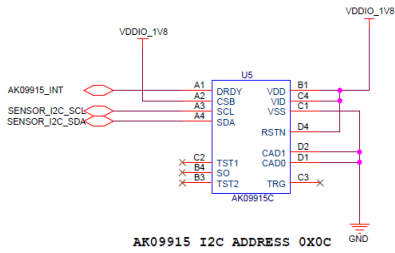
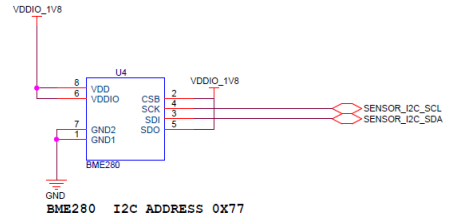
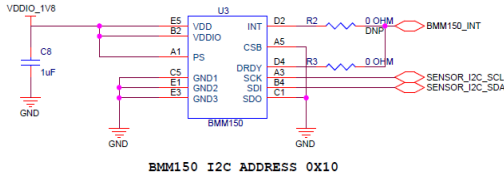

BHI260AB shuttle board schematics

**Headquarters
Bosch Sensortec GmbH**

Gerhard-Kindler-Strasse 9
72770 Reutlingen · Germany
Telephone +49 7121 3535 900
Fax +49 7121 3535 909

www.bosch-sensortec.com